

| BASMEL | BASSKEEPER WALL | CAMOU | COOKIE | CORALREEF | COSMOS | DECOART | FOAMSORB | IVORY | LFTONE | NOVEN | PYRAMID | REFLEX | SEAFOAM | SNOWSORB | STRIPESORB | STRIPESORB ARC | SWELL | WAVYFUSER | WUSORBER |

Prior to application, always clean all surfaces before applying any glue ensuring them free of dust or grease. Mark the measurements of the panel on the surface you are applying the panel to. Apply double sided temporary adhesive patches to the back of the panel as shown. The adhesive temporary patches are activated by pressure. To ensure their maximum adhesion strength they are not repositionable, so measure twice and glue only once.

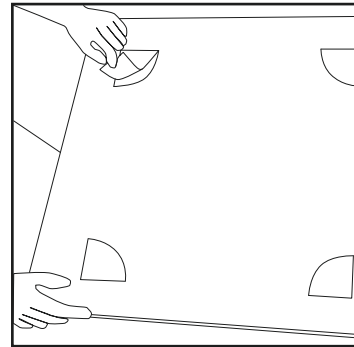

Then apply as shown in grey, the definitive PU mounting glue without solvents, for permanent applications (not-included). Apply the cords of glue marked in grey as shown on this left example image.

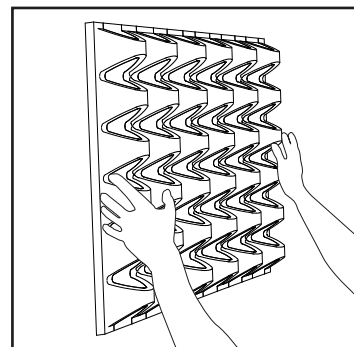

Place the panel on the surface and press it gently and homogeneously during the mounting glue's curing time, average aprox. time 2 hours.

For ceiling panels a temporary auxiliar supporting bar (anchor) between the floor and the panel, can be used .

Ensure taking extra care to always use a protective thick and enough dense and very clean material like foam (or a dense pillow) between the panel and the anchor to ensure not to damage the panel finishings.

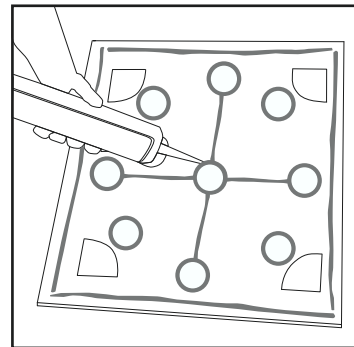

Between the anchor and the floor a protective material like a simple piece of wood or dense foam also should be used to protect floor finishings.

NOTICE

Adhesive time is entirely dependant on the weight of the panel to be glued . Always consult the mounting glue specifications. Adhesive gluing times can vary with humidity and temperature. Make sure that the room temperature and humidity is within the acceptable product values available on our website.

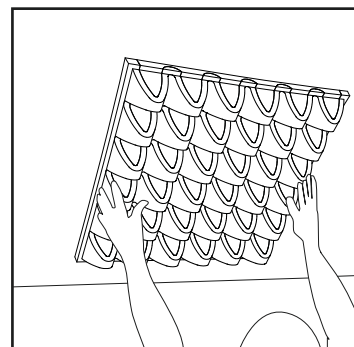

| BASMEL | COOKIE | LIGHTWALLTRAP | MELLOWALLTRAP | WALLTRAP |

Read instructions in full prior to install and then choose one of these two mounting methods and apply it: Ceiling installation method can either be with horizontal suspension cables (left) installed on the walls; or suspension method directly from the ceiling using metallic hooks and wires (right);

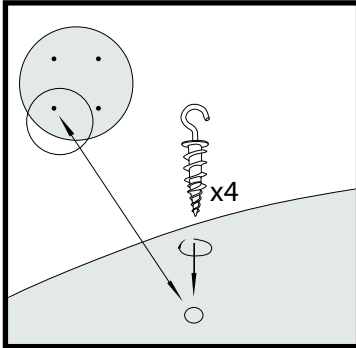

Accessories' kit; the product is supplied with the necessary accessories. Optionally suspension wires on the right are sold separately and can be made available upon demand. On the back of the panel, locate the mounting hooks.

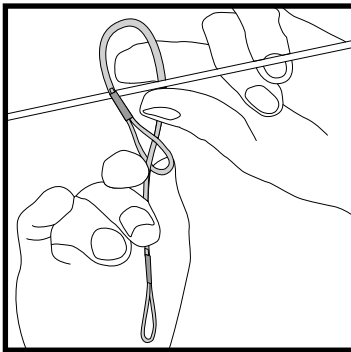
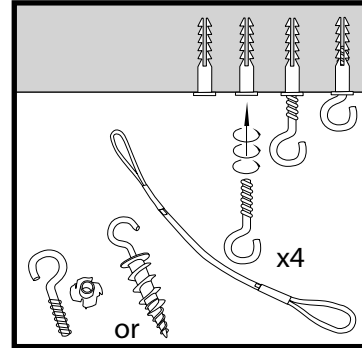

Measure the ceiling and mark it as needed to best fit its area.
1st method: install suspension cables to the wall;
2nd method: install ceiling sleeves for the suspension metal hooks, use four (4) suspension points per panel, do ensure their robust fixation prior to panel suspension.

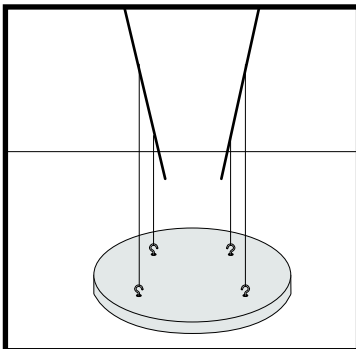
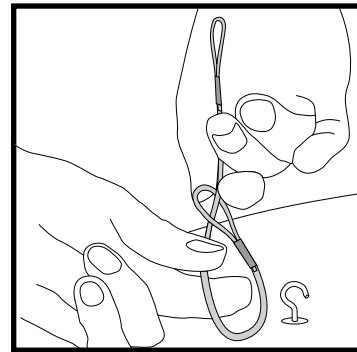

For panels with lights prepare ahead electrical connections .

1st method: From the horizontal wires install vertical suspension wires;
or
2nd method: Suspend the wires to ceiling metallic hooks.

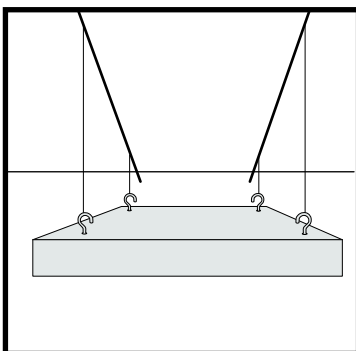
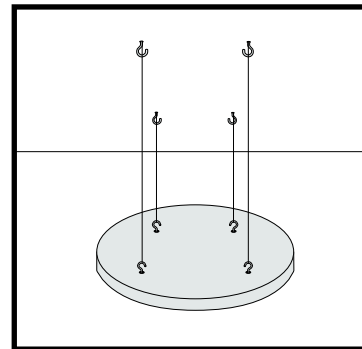

Depending on the size of the panel 1 or 2 persons can be required to suspend it. Always ensure clean and gently handling as panel finishings can be fragile. Secure the wires to the hooks on the panel to suspend it.

